

HİSARİNOKS

'Paslanmaz Çelik Tedarikçiniz'

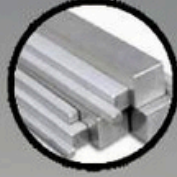

Paslanmaz Çelik Sac



Paslanmaz Çelik Dolu Grubu



Paslanmaz Çelik Boru



Paslanmaz Çelik Fittings Grubu



Paslanmaz Çelik Profil





VİZYON

Paslanmaz çelik sektöründe 15 yıllık deneyim, teknik bilgi ve tecrübe ile uzmanlaşmış bir kuruluş olarak, Hisarinoks Çelik, sektörün öncü firmalarından biri olmayı hedeflemektedir. Müşteri memnuniyeti odaklı hizmet anlayışımızla, kaliteli ürünler sunarak sektördeki konumumuzu sürekli olarak daha ileriye taşımayı amaçlıyoruz.

MİSYON

Hisarinoks Çelik olarak, paslanmaz çelik ürünlerinin satışında müşterilerimizin ihtiyaç ve beklentilerine en iyi şekilde cevap vermek temel ilkemizdir. Kaliteli ve dürüst hizmet anlayışımızla, ürün yelpazemizi sürekli genişleterek, sektördeki yenilikleri takip ediyor ve müşterilerimize en iyi çözümleri sunuyoruz. Tüm ekibimizle birlikte, paslanmaz çelik sektöründe güvenilir bir iş ortağı olma yolunda çalışmaya devam ediyoruz.

HİSARİNOKS
'Paslanmaz Çelik Tedarikçiniz'

DESENLİ YÜZEYLER PATTERNED SURFACES

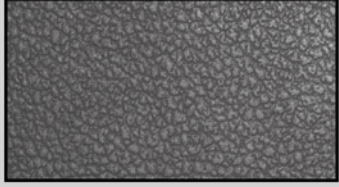

DERİ DESEN



MİKRO NOKTA DESEN

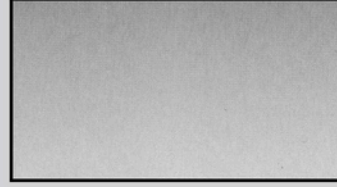

MAT

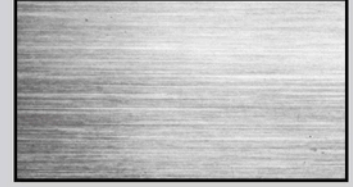

SCOTCHBRITE FIRÇA YÜZÜ

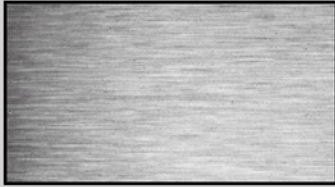

TAŞLI

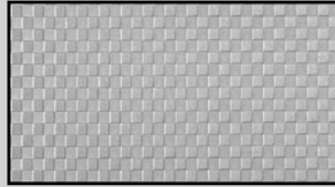

KARE DESEN

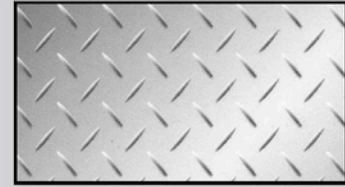

BAKLAVA DESEN

SAC LEVHALAR

BOY KESME 0,40'tan 12 mm kalınlığa kadar
DİLME 0,40'tan 5 mm kalınlığa kadar
PLAZMA KESİM 1mm'den 100 mm kalınlığa kadar
TAŞLAMA 1 mm'den 3 mm'ye kadar

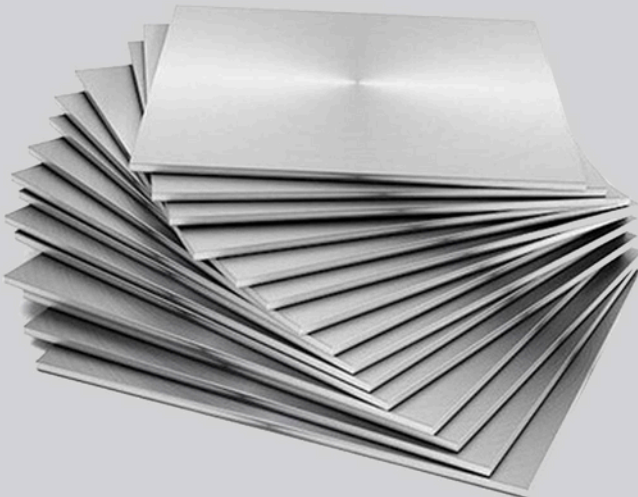

Kalınlık	1000x2000	1250x2500	1500x3000	2000x6000
0.30	4.8	7.5		
0.40	6.4	10		
0.50	8.0	12.5	18	
0.60	9.6	15	21.6	
0.70	11.2	17.5	25.2	
0.80	12.8	20.0	28.8	
1	16.0	25.0	36.0	
1.25	20.0	31.3	45.0	
1.5	24.0	37.5	54.0	
2.0	32.0	50.0	72.0	
2.5	40.0	62.5	90.0	
3.0	48.0	75.0	108.0	288
4.0	64.0	100.0	144.0	284
5.0	80.0	125.0	180.0	480
6.0	96.0	150.0	216.0	576
8.0	128.0	200.0	288.0	768
10.0	160.0	250.0	360.0	960
12.0	192.0	300.0	432.0	1152

PASLANMAZ DİKİŞLİ BORU ÖLÇÜ ve BİRİM AĞIRLIKLARI

DIN 2463

DIŞ ÇAP	1,0	1,2	1,5	2,0	2,5	3,0	4,0	5,0	6,0
10	0,225	0,264	0,319						
12	0,275	0,325	0,394	0,500					
14	0,326	0,385	0,470	0,601					
15	0,351	0,415	0,507	0,651					
16	0,376	0,445	0,545	0,701					
17,2	0,406	0,481	0,590	0,761	0,921				
18	0,426	0,505	0,620	0,801					
19	0,452	0,536	0,659	0,854					
20	0,476	0,565	0,695	0,901					
21,3	0,508	0,604	0,744	0,967	1,177				
22	0,526	0,625	0,770	1,002					
23	0,551	0,655	0,808	1,051					
25	0,601	0,715	0,883	1,152	1,409				
26,9	0,649	0,772	0,954	1,247	1,527	1,795	1,795		
28	0,676	0,805	0,995	1,302	1,596	1,878	1,878		
30	0,726	0,865	1,070	1,402	1,722	2,028	2,028		
32	0,776	0,925	1,146	1,502	1,847	2,178	2,178		
33,0			1,184						
33,7	0,819	0,977	1,209	1,588	1,953	2,306	2,306		
35	0,851	1,016	1,258	1,653	2,035	2,404	2,404		
38	0,929	1,109	1,375	1,808	2,229	2,637	2,637		
40	0,977	1,116	1,446	1,903	2,348	2,779	2,779		
42,4	1,037	1,238	1,536	2,023	2,498	2,960	2,960		
45	1,102	1,316	1,634	2,153	2,661	3,155	3,155		
48,3	1,184	1,415	1,758	2,319	2,867	3,403	3,403		
50	1,227	1,466	1,822	2,404	2,974	3,531	3,531		
50,8	1,247	1,490	1,852	2,444		3,591	3,591		
51	1,252	1,496	1,859	2,454	3,036				
52	1,277	1,526	1,897	2,504	3,099	3,681	3,681		
54	1,327	1,587	1,972	2,604	3,224	3,831	3,831		
57			2,085	2,754	3,412	4,057	4,057		
60,3	1,485	1,776	2,209	2,920	3,618	4,304	4,304		
63,5	1,565		2,329	3,080	3,819	4,545	4,545		
70	1,728	2,067	5,573	3,405	4,226	5,033	5,033		
76,1	1,881	2,251	2,802	3,711	4,607	5,491	5,491		
80	1,978	2,368	2,948	3,906	4,852	5,784	5,784		
84				4,107					
88,9			3,283	4,352	5,409	6,453	6,453		
101,6			3,760	4,988	6,204	7,407	7,407	12,094	14,363
104			3,850	5,108	6,354	7,587	7,587	12,395	14,724
114,3			4,237	5,624	6,999	8,361	8,361	13,984	16,271
129			4,789	6,360	7,919	9,465	9,465	15,525	18,480
139,7			5,191	6,896	8,589	10,269	10,269	16,864	20,087
154			5,728	7,612	9,484	11,343	11,343	18,655	22,236
168,3			6,245	8,328	10,397	12,417	12,417	20,445	24,384

PASLANMAZ PROFİL AĞIRLIK CETVELİ

KARE PROFİL

EBAT (mm)	1,0	1,2	1,5	2,0	2,5	3,0	4,0	5,0	6,0
12*12	0,358	0,415	0,508						
15*15	0,453	0,538	0,661						
16*16	0,485	0,576	0,709	0,920					
20*20	0,613	0,729	0,900	1,175					
25*25	0,772	0,921	1,140	1,494	1,846	2,179			
30*30	0,932	1,112	1,379	1,813	2,222	2,245			
35*35	1,091	1,303	1,618	2,132	2,629	3,118			
40*40	1,251	1,495	1,857	2,451	3,036	3,602	4,708		
45*45	1,410	1,686	2,097	2,770	3,433	4,081	5,309		
50*50	1,570	1,878	2,336	3,089	3,818	4,559	5,960		
60*60			2,814	3,727	4,607	5,516	7,222		
70*70			3,293	4,365	5,408	6,473	8,504		
80*80			3,771	5,003	6,203	7,430	9,807	12,095	
100*100		4,728	6,279	7,918	9,343	12,358	15,322	18,236	18,236
120*120			7,555		11,257	14,910	18,512	22,064	22,064

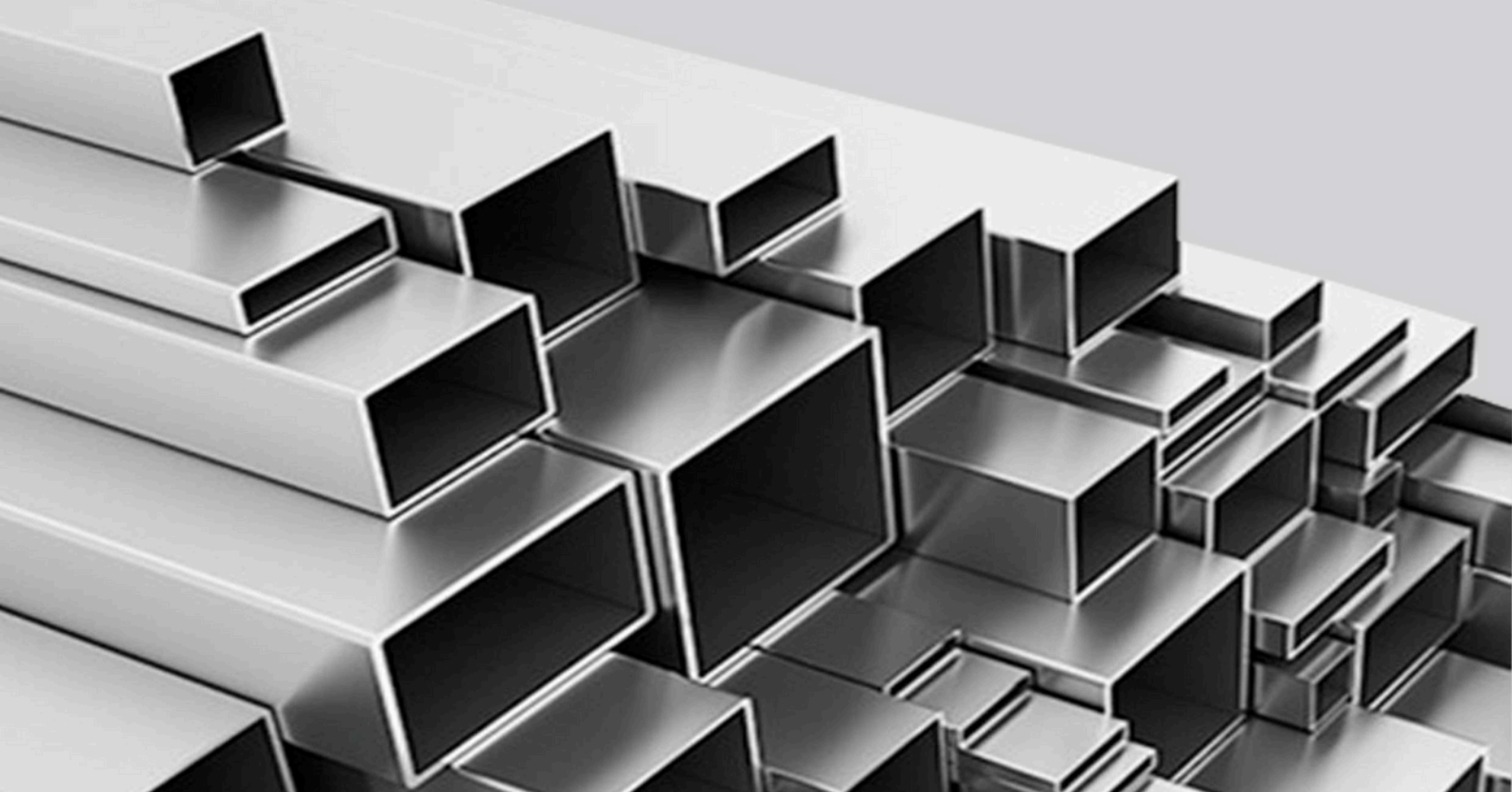

PASLANMAZ PROFİL AĞIRLIK CETVELİ

DİKDÖRTGEN PROFİL

EBAT (mm)	1,0	1,2	1,5	2,0	2,5	3,0	4,0	5,0	6,0
20*10	0,453	0,538	0,661						
20*15	0,533	0,634	0,781						
25*15	0,613	0,729	0,900	1,175					
30*10	0,613	0,729	0,900						
30*15	0,693	0,825	1,020	1,335					
30*20	0,852	0,921	1,140	1,494					
35*20	0,852	1,017	1,259	1,654					
40*15	0,852	1,017	1,259	1,654					
40*20	0,926	1,112	1,379	1,813					
40*30	1,091	1,303	1,618	2,132	2,661	3,156			
50*20	1,091	1,303	1,618	2,132					
50*25		1,399	1,738	2,292					
50*30	1,251	1,495	1,857	2,451					
50*40		1,686	2,097	2,770	3,412	4,081			
60*20		1,495	1,857	2,451					
60*30		1,686	2,097	2,770	3,421	4,081			
60*40		1,878	2,336	3,089	3,819	4,559	5,960		
80*40		2,261	2,814	3,727	4,600	5,516	7,222		
80*60			3,293	4,365	5,408	6,473	8,504		
100*40			3,293	4,365	5,408	6,473	8,504		
100*50				4,684	5,790	6,952	9,115	11,268	
100*60				5,003		7,430	9,807	12,095	
120*40				5,003		7,430	9,807		
120*60				5,642		8,387	11,083	13,728	16,324
120*80				6,279		9,343	12,358	15,322	18,236
150*50				6,279		9,343	12,358	15,322	18,236



ÇUBUK ve MİL TEORİK AĞIRLIKLARI (KG9/MT)

Ø	mm	kg/mt
Ø	3	0.06
Ø	4	0.10
Ø	5	0.16
Ø	6	0.22
Ø	7	0.30
Ø	8	0.40
Ø	9	0.50
Ø	10	0.62
Ø	11	0.75
Ø	12	0.89
Ø	13	1.05
Ø	14	1.21
Ø	15	1.39
Ø	16	1.59
Ø	17	1.79
Ø	18	2.01
Ø	19	2.24
Ø	20	2.48
Ø	21	2.73
Ø	22	2.99
Ø	24	3.57
Ø	25	3.88
Ø	26	4.19
Ø	28	4.86
Ø	30	5.58
Ø	32	6.31
Ø	35	7.55
Ø	38	8.91
Ø	40	9.92
Ø	45	12.50
Ø	50	15.50
Ø	55	18.76
Ø	60	22.30
Ø	65	26.20

Ø	mm	kg/mt
Ø	70	30.38
Ø	75	34.88
Ø	80	39.60
Ø	85	44.80
Ø	90	50.22
Ø	95	55.90
Ø	100	62.00
Ø	105	68.30
Ø	110	75.00
Ø	115	81.60
Ø	120	89.00
Ø	125	96.50
Ø	130	104.78
Ø	135	113.00
Ø	140	121.00
Ø	150	139.50
Ø	160	158.22
Ø	165	168.80
Ø	170	179.18
Ø	180	200.88
Ø	185	212.20
Ø	190	223.82
Ø	200	248.00
Ø	210	273.42
Ø	220	300.08
Ø	230	327.98
Ø	240	357.12
Ø	250	387.50
Ø	260	419.12
Ø	280	486.06
Ø	285	503.60
Ø	300	558.0
Ø	340	716.72
Ø	400	992.00

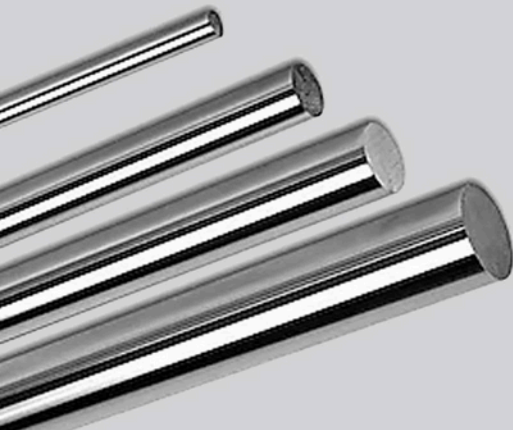

ALTI KÖŞE DIN 176

EBAT (ws/mm)	AĞIRLIK (kg/M)
11	0.82
13	1.15
14	1.33
15	1.53
17	1.97
19	2.45
22	3.29
24	3.92
27	4.96
30	6.12
32	6.96
36	8.81
41	11.43
45	13.77
50	17.00

KARE DIN 178

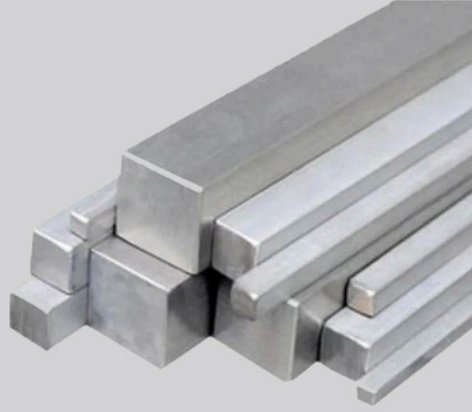

EBAT (ws/mm)	AĞIRLIK (kg/M)
6x6	0.28
8x8	0.51
10x10	0.79
12x12	1.14
14x14	1.55
15x15	1.78
16x16	2.02
18x18	2.56
20x20	3.16
22x22	3.82
25x25	4.94
30x30	7.11
35x35	9.68
40x40	12.64
50x50	19.75
60x60	28.46
80x80	50.56
100x100	79.00

KÖŞEBENT DIN 1028

EBAT (ws/mm)	AĞIRLIK (kg/M)
20 x 20 x 3	0.880
25 x 25 x 3	1.120
25 x 25 x 4	1.450
30 x 30 x 3	1.360
30 x 30 x 4	1.780
30 x 30 x 5	2.180
35 x 35 x 4	2.100
40 x 40 x 3	1.813
40 x 40 x 4	2.420
40 x 40 x 5	2.970
50 x 50 x 3	2.284
50 x 50 x 4	3.014
50 x 50 x 5	3.770
50 x 50 x 6	4.470
60 x 60 x 6	5.420
70 x 70 x 7	.380
80 x 80 x 8	9.660
100 x 100 x 10	15.000



LAMA (KG/MT)
DIN 1016,1017,1543

KALINLIK EBAT	2	3	4	5	6	8	10	12	15
10	0.16	0.24	0.32	0.40					
15	0.25	0.36	0.48	0.60					
20	0.32	0.48	0.64	0.80	0.95	1.27			
25	0.40	0.60	0.80	0.99	1.19	1.59			
30	0.48	0.72	0.95	1.19	1.43	1.91	2.29		
35	0.56	0.83	1.11	1.39	1.67	2.23	2.78		
40	0.64	0.95	1.27	1.59	1.91	2.54	3.18	3.82	
45	0.72	1.07	1.43	1.79	2.15	2.86	3.58	4.29	
50	0.80	1.19	1.59	1.99	2.39	3.18	3.98	4.77	
60		1.43	1.91	2.39	2.86	3.82	4.77	5.72	
70		1.67	2.23	2.78	3.34	4.45	5.57	6.68	
80		1.91	2.54	3.18	3.82	5.09	6.36	7.63	
90		2.15	2.66	3.58	4.29	5.72	7.16	8.59	
100		2.39	3.18	3.98	4.77	6.36	7.95	9.54	11.93
110			3.50	4.37	5.25	7.00	8.75	10.49	13.12
120			3.82	4.77	5.72	7.63	9.54	11.45	14.31
130				5.17	6.20	8.27	10.34	12.40	15.50
140				5.57	6.68	8.90	11.13	13.36	16.70
150				5.96	7.16	9.54	11.93	14.31	17.89
160				6.36	7.63	10.18	12.72	15.26	19.08
180				7.16	8.59	11.45	14.31	17.17	21.47
200				7.95	9.54	12.72	15.90	19.08	23.85
250				9.94	11.94	15.90	19.88	23.85	29.81



HİSARINOKS

'Paslanmaz Çelik Tedarikçiniz'

0 (212) 558 58 01

satis@hisarinoks.com.tr

<https://www.hisarinoks.com.tr>

Seyit Nizam Mahallesi Demirciler Sitesi

6. Cad No:83 Kapı No:84

Zeytinburnu / İSTANBUL